



ASSEMBLY INSTRUCTION

ZAHRA OTTOMAN

ITEM CODE: 73205

Imported by Amart Furniture Pty Ltd, Qld, Brisbane Australia.

For any assistance with assembly or for missing parts please phone Amart Furniture, Customer Service Free call 1800 351 084

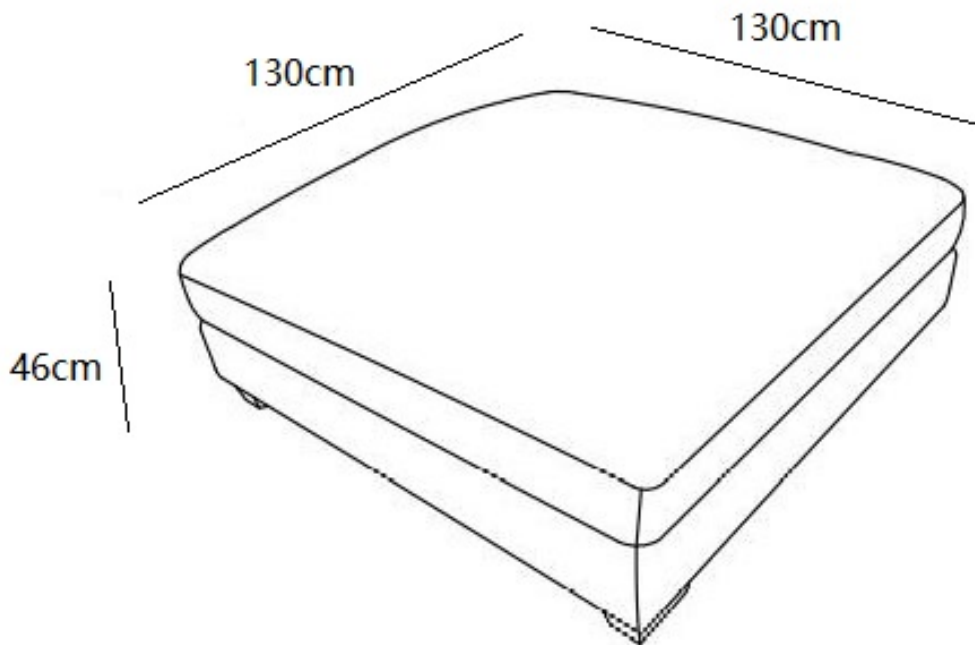

Imported by Amart Furniture Pty Ltd, Qld, Brisbane Australia.

For any assistance with assembly or for missing parts please phone Amart Furniture, Customer Service Free call 1800 351 084

Before you start:

1. Choose a clean, level, spacious assembly area. Avoid hard surfaces that may damage the product
2. Take care when lifting. Product should be assembled as near as possible to the point of use
3. Ensure that you have all required contents for complete assembly
4. Always read the assembly instructions carefully before beginning assembly.
5. Keep all hardware parts and packaging out of reach of small children.
6. Do not over tighten the screws and bolts as this may damage the threads

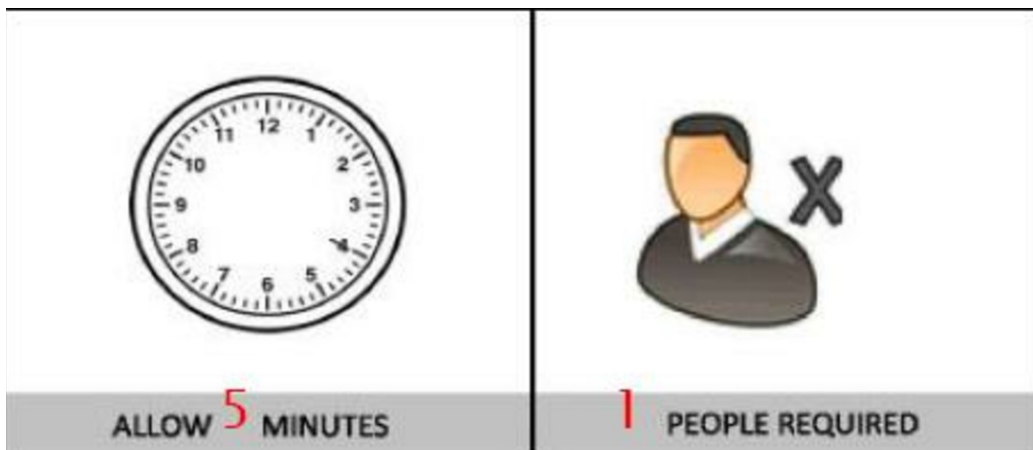



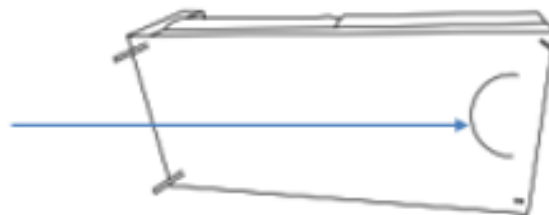

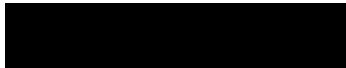
Hardware and legs are located in dust cover zipper compartment underneath the lounge.



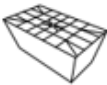
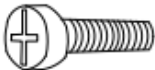

Included:

NO.	Picture	Description	ottoman
A	 H:7.5CM	Plastic Leg	4pcs
B	 M8X60MM	Bolt	4pcs
C	 8-16MM	Metal Washer	4pcs
D	 H:6CM	Middle Leg	1pc
E		Plastic Washer	1pc

Not Included:

F	Screw-driver	
----------	--------------	-------------------------------------------------------------------------------------

ASSEMBLY INSTRUCTIONS

STEP 1: Turn over onto blanket or carpet to ensure no damage to item. Attach washer (C) to bolt (B) and insert into plastic leg (A) and screw into predrilled holes with a screwdriver (F), turning clockwise until feet are tightened securely. For centre leg, attach washer (E) to the leg (D) and rotate tightly until fixed.

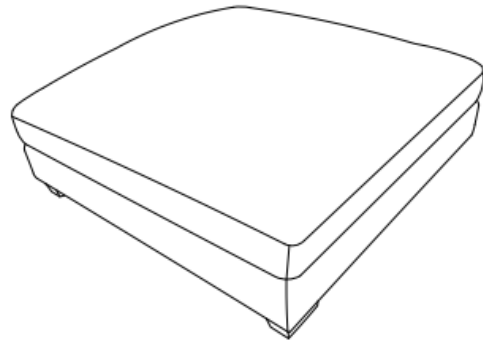
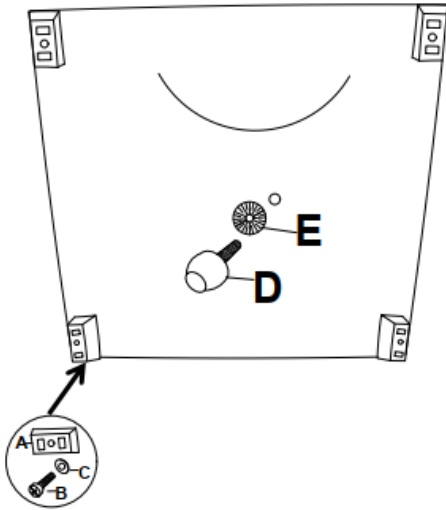

STEP 3: Assembly complete

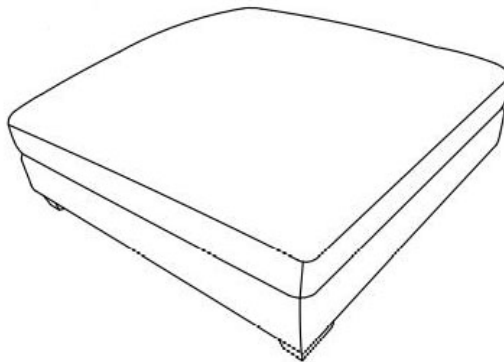

Fabric Care and Maintenance



REGULAR CARE:

- Protect from direct sunlight
- Vacuum regularly using low suction
- Rotate reversible cushions regularly

CLEANING:

- Do not remove cushion covers for separate cleaning even though they may have zippers
- Do not wash, Do not dry clean, Do not shampoo clean
- Clean with hot water extraction machine. Professional cleaning recommended
- Do not use dishwashing liquid or laundry detergent
- Use only upholstery detergents
- Do not wet filling
- Dry in shade away from direct heat and sunlight
- Allow to dry thoroughly before re-use

SPOT CLEANING:

- Do not rub
- Do not spot clean with any solvent
- Treat spills and stains as soon as possible
- Gently scrape off any soil or mop any liquid from the surface of the fabric
- Apply proprietary cleaning agents strictly according to instructions to remove the residue of the spill
- Do not saturate the fabric or interior with water or other cleaning liquids

WARNING:

Apply only water-based soil resist (fabric protection) treatments. Do not use aerosol products

* PILLING IS NOT A FABRIC DEFECT OR FAULT AND IS NOT COVERED BY WARRANTY

* PILLING IS A NORMAL OCCURRENCE CAUSED BY WEAR AND TEAR AND DOES NOT AFFECT THE DURABILITY OR FUNCTIONALITY OF THE FABRIC AND IS EASILY REMOVED